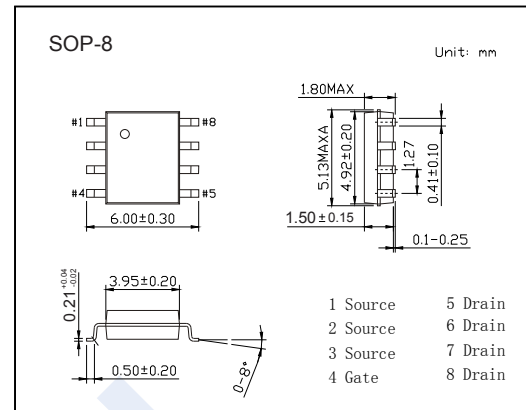
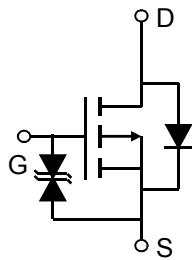

P-Channel MOSFET

AO4455 (KO4455)

■ Features

- $V_{DS} = -30V$
- $I_D = -17 A$ ($V_{GS} = -20V$)
- $R_{DS(ON)} < 6.2m\Omega$ ($V_{GS} = -20V$)
- $R_{DS(ON)} < 7.2m\Omega$ ($V_{GS} = -10V$)
- ESD Rating: 2000V HBM

■ Absolute Maximum Ratings $T_a = 25^\circ C$

Parameter	Symbol	Rating	Unit	
Drain-Source Voltage	V_{DS}	-30	V	
Gate-Source Voltage	V_{GS}	± 25		
Continuous Drain Current	I_D	$T_A = 25^\circ C$	-17	A
		$T_A = 70^\circ C$	-14	
Pulsed Drain Current	I_{DM}	-182		
Power Dissipation	P_D	$T_A = 25^\circ C$	3.1	W
		$T_A = 70^\circ C$	2	
Thermal Resistance.Junction- to-Ambient	R_{thJA}	$t \leq 10s$	40	$^\circ C/W$
		Steady-State	75	
Thermal Resistance.Junction- to-Lead	R_{thJL}	24		
Junction Temperature	T_J	150	$^\circ C$	
Junction Storage Temperature Range	T_{stg}	-55 to 150		

P-Channel MOSFET

AO4455 (KO4455)

■ Electrical Characteristics Ta = 25°C

Parameter	Symbol	Test Conditions	Min	Typ	Max	Unit
Drain-Source Breakdown Voltage	V _{DSS}	I _D =-250 μA, V _{GS} =0V	-30			V
Zero Gate Voltage Drain Current	I _{DSS}	V _{DS} =-30V, V _{GS} =0V			-1	μA
		V _{DS} =-30V, V _{GS} =0V, T _J =55°C			-5	
Gate-Body leakage current	I _{GSS}	V _{DS} =0V, V _{GS} =±20V			±1	μA
		V _{DS} =0V, V _{GS} =±25V			±10	
Gate Threshold Voltage	V _{GS(th)}	V _{DS} =V _{GS} , I _D =-250μA	-1.5		-2.6	V
Static Drain-Source On-Resistance	R _{DS(on)}	V _{GS} =-20V, I _D =-15A			6.2	mΩ
		V _{GS} =-20V, I _D =-15A T _J =125°C			9	
		V _{GS} =-10V, I _D =-15A			7.2	
		V _{GS} =-6V, I _D =-10A			9.5	
Forward Transconductance	g _{FS}	V _{DS} =-5V, I _D =-15A		48		S
Input Capacitance	C _{iss}	V _{GS} =0V, V _{DS} =-15V, f=1MHz		2823	3400	pF
Output Capacitance	C _{oss}			574		
Reverse Transfer Capacitance	C _{rss}			424	600	
Gate resistance	R _g		V _{GS} =0V, V _{DS} =0V, f=1MHz	2.1		
Total Gate Charge	Q _g	V _{GS} =-10V, V _{DS} =-15V, I _D =-15A		54	76	nC
Gate Source Charge	Q _{gs}			9		
Gate Drain Charge	Q _{gd}			16		
Turn-On DelayTime	t _{d(on)}	V _{GS} =-10V, V _{DS} =-15V, R _L =1Ω, R _{GEN} =3Ω		12.5		ns
Turn-On Rise Time	t _r			12.5		
Turn-Off DelayTime	t _{d(off)}			49		
Turn-Off Fall Time	t _f			109		
Body Diode Reverse Recovery Time	t _{rr}	I _F =-15A, di/dt=100A/us		22.3	32	nC
Body Diode Reverse Recovery Charge	Q _{rr}			8.8		
Maximum Body-Diode Continuous Current	I _S				-4.2	A
Diode Forward Voltage	V _{SD}	I _S =-1A, V _{GS} =0V			-1	V

Note :The static characteristics in Figures 1 to 6 are obtained using <300us pulses, duty cycle 0.5% max.

■ Marking

Marking	4455 KC****
---------	----------------

P-Channel MOSFET AO4455 (KO4455)

Typical Characteristics

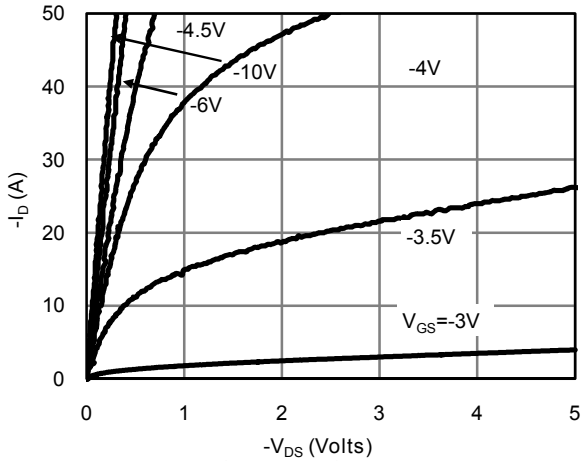

Fig 1: On-Region Characteristics

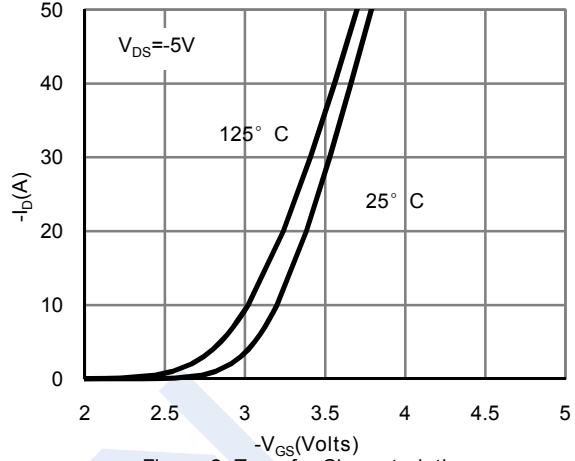

Figure 2: Transfer Characteristics

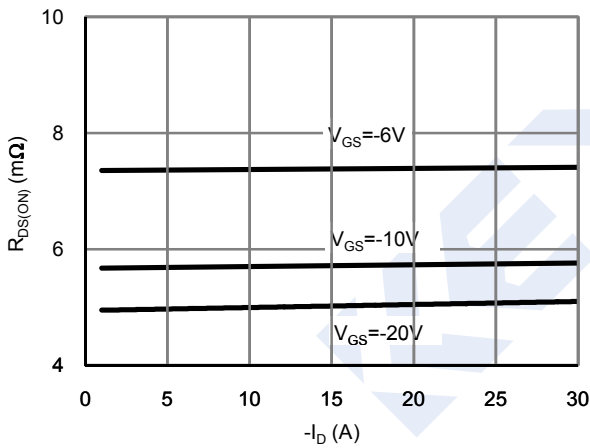

Figure 3: On-Resistance vs. Drain Current and Gate Voltage

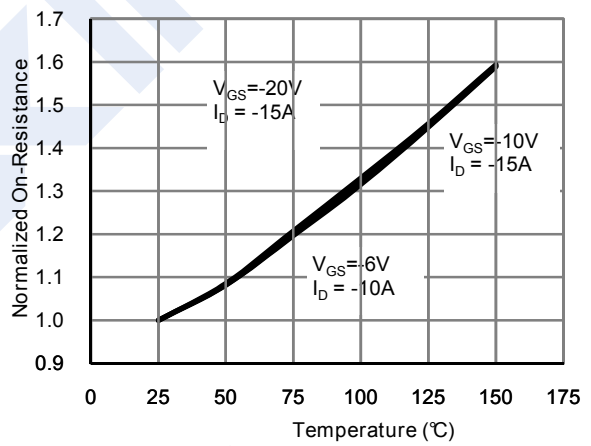

Figure 4: On-Resistance vs. Junction Temperature

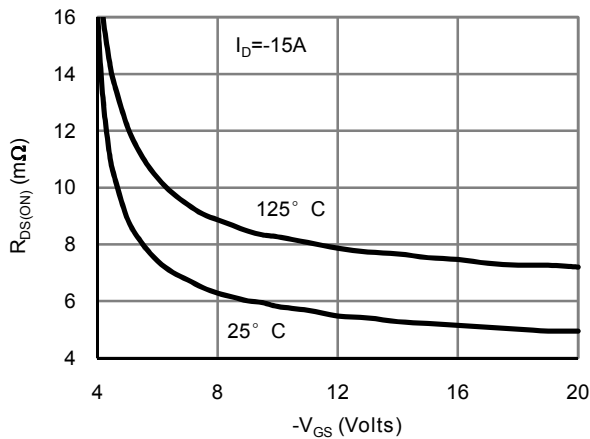

Figure 5: On-Resistance vs. Gate-Source Voltage

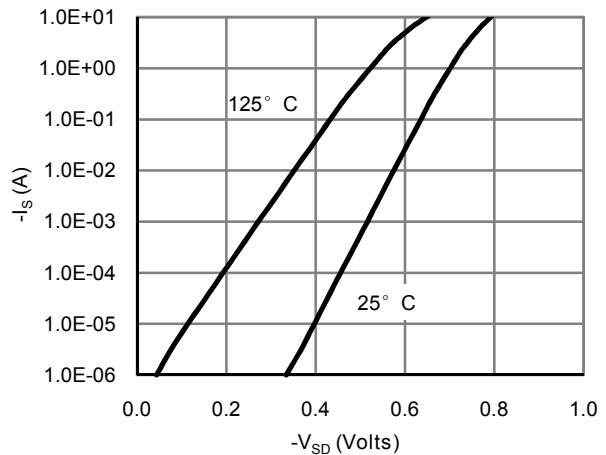

Figure 6: Body-Diode Characteristics

P-Channel MOSFET AO4455 (KO4455)

■ Typical Characteristics

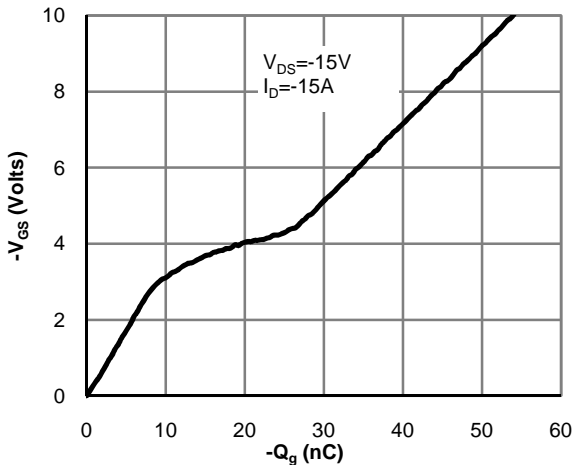

Figure 7: Gate-Charge Characteristics

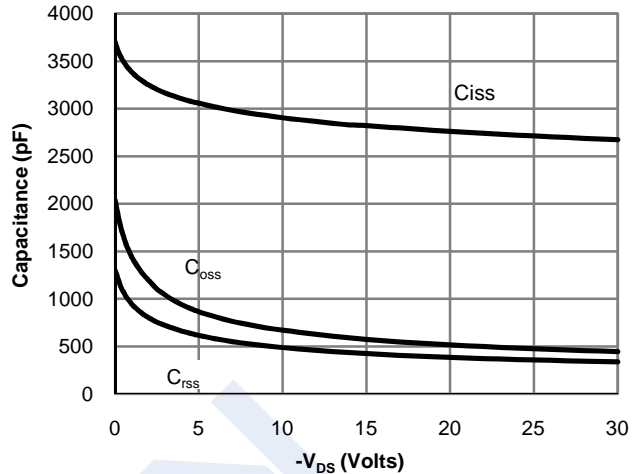

Figure 8: Capacitance Characteristics

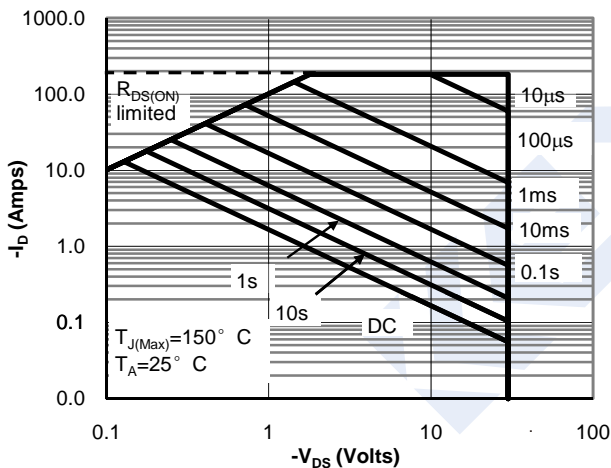

Figure 9: Maximum Forward Biased Safe

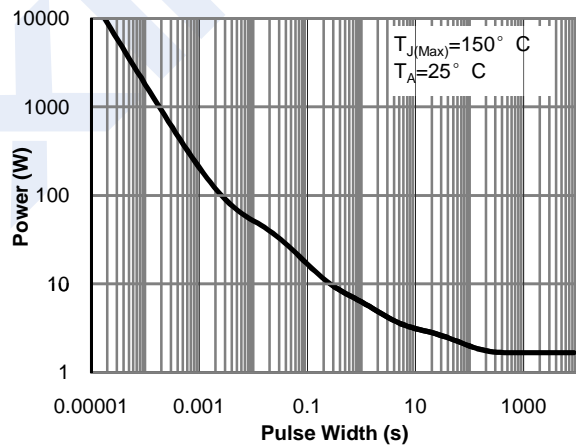

Figure 10: Single Pulse Power Rating Junction-to-Ambient (Note E)

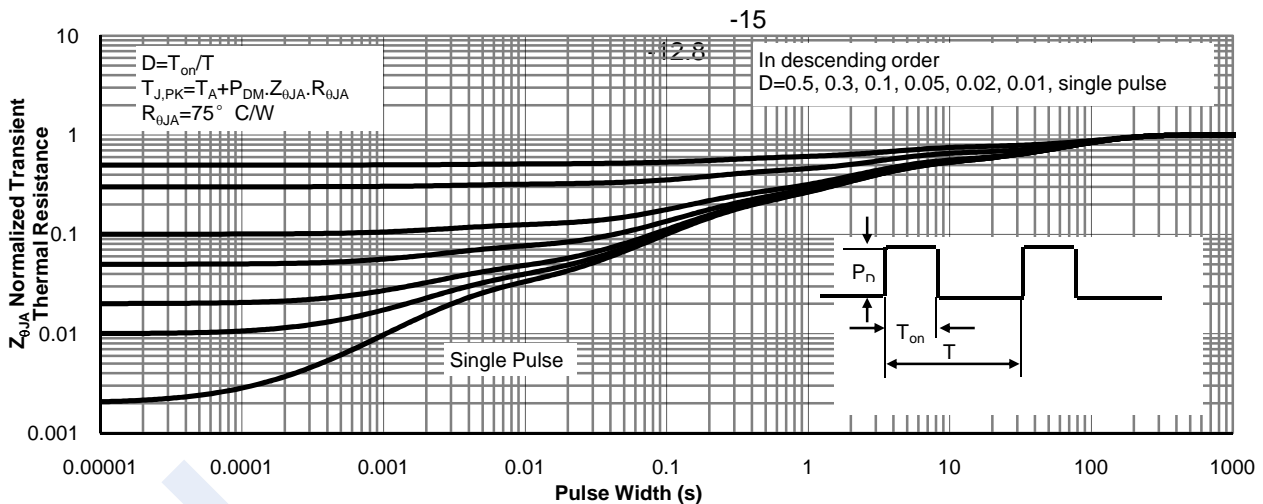

Figure 11: Normalized Maximum Transient Thermal Impedance